

PARTS MANUAL

MODEL

GB250

STYLE

GB00-250-000-000

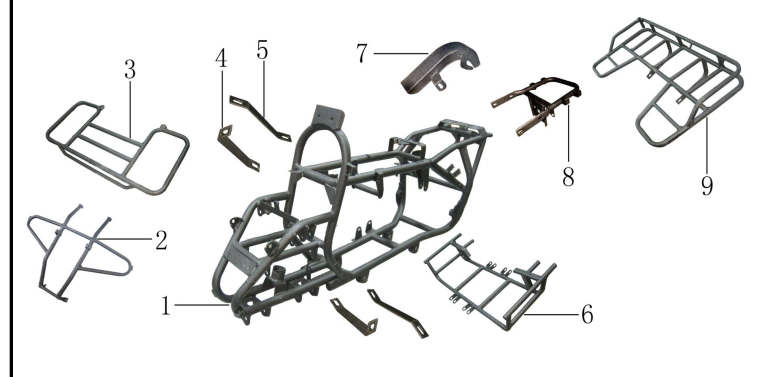
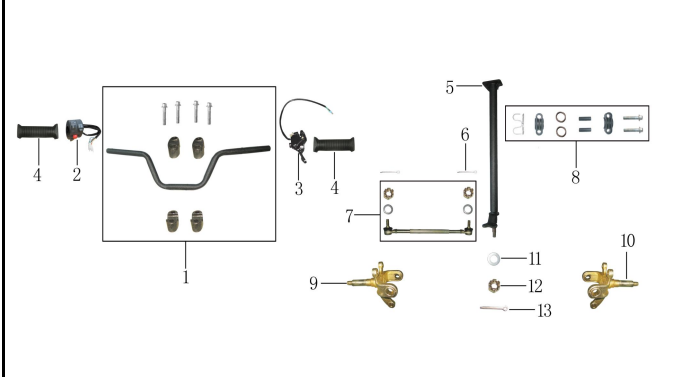
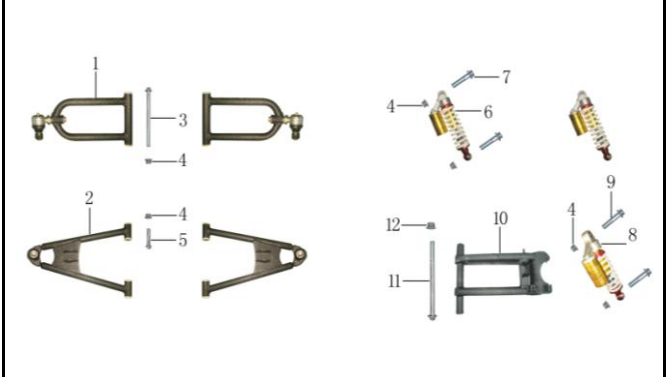
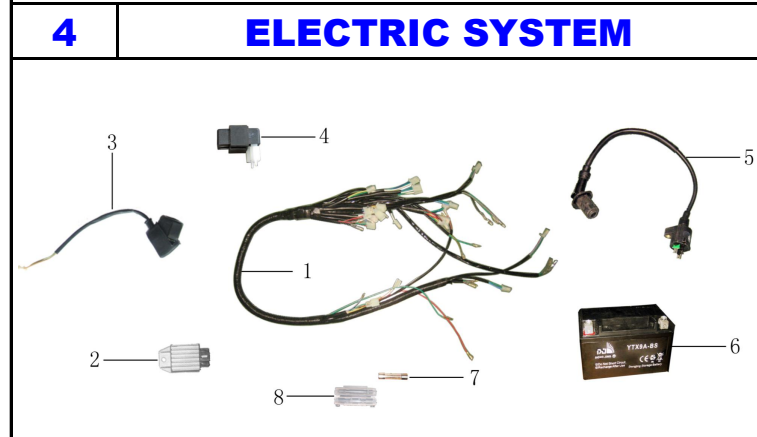
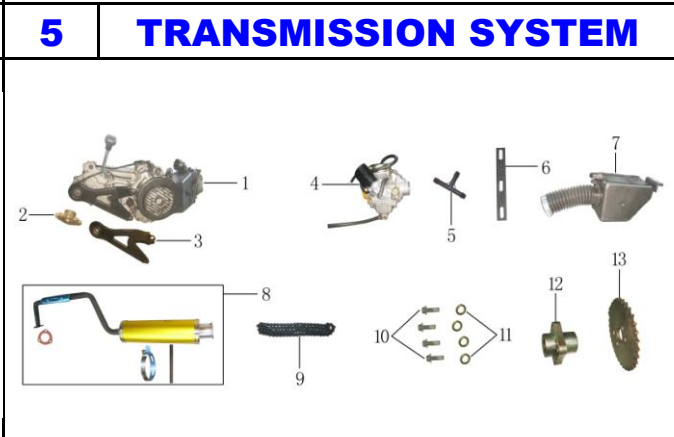
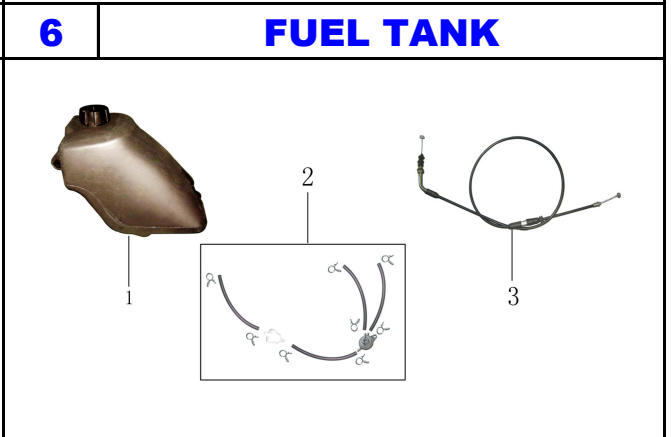
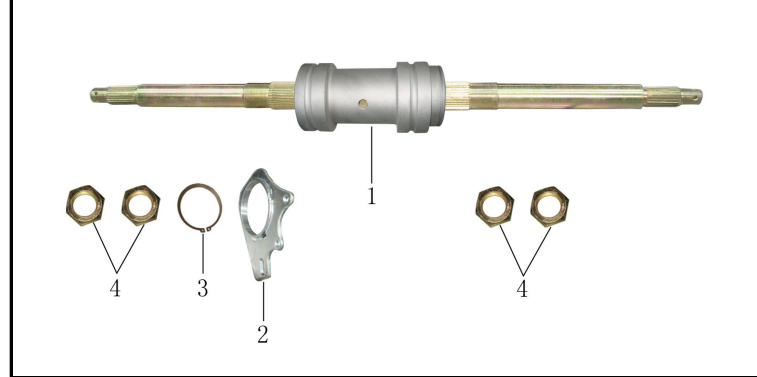
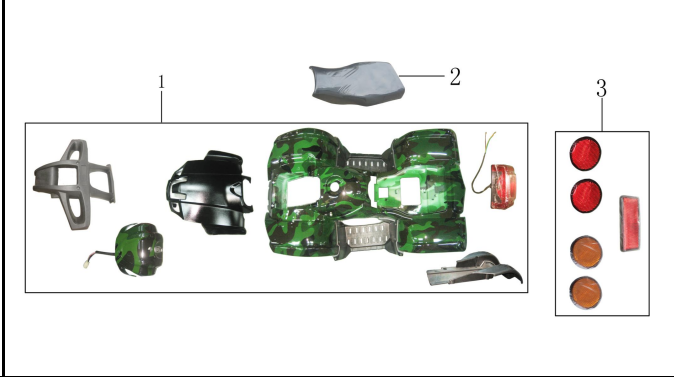
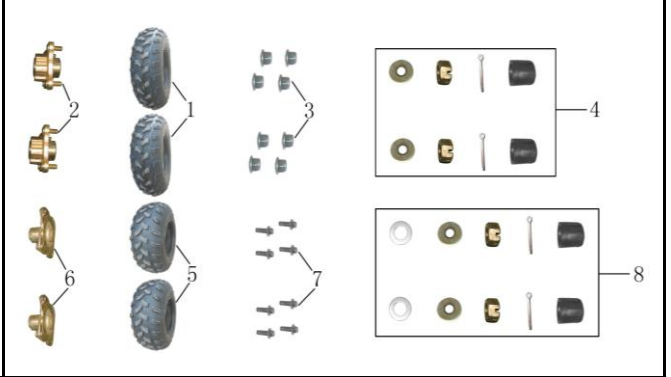
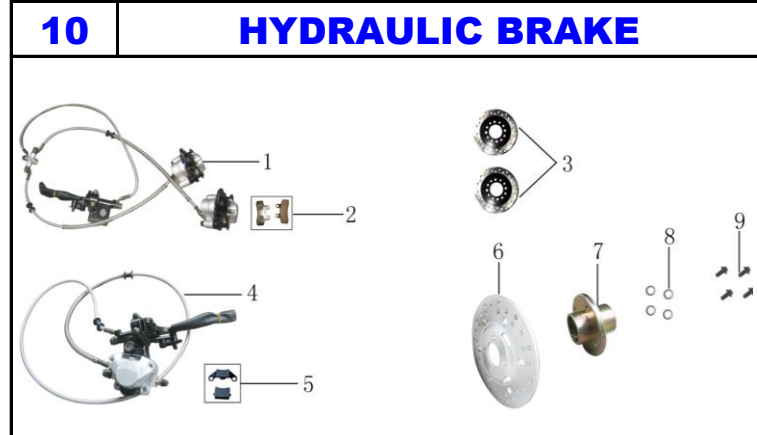

PARTS SYSTEM

1	FRAME SYSTEM	2	STEERING SYSTEM	3	SUSPENSION SYSTEM
					
4	ELECTRIC SYSTEM	5	TRANSMISSION SYSTEM	6	FUEL TANK
					
7	REAR AXLE	8	BODY KITS	9	WHEEL COMPLETE
10	HYDRAULIC BRAKE				

1.FRAME SYSTEM

LEVEL 1

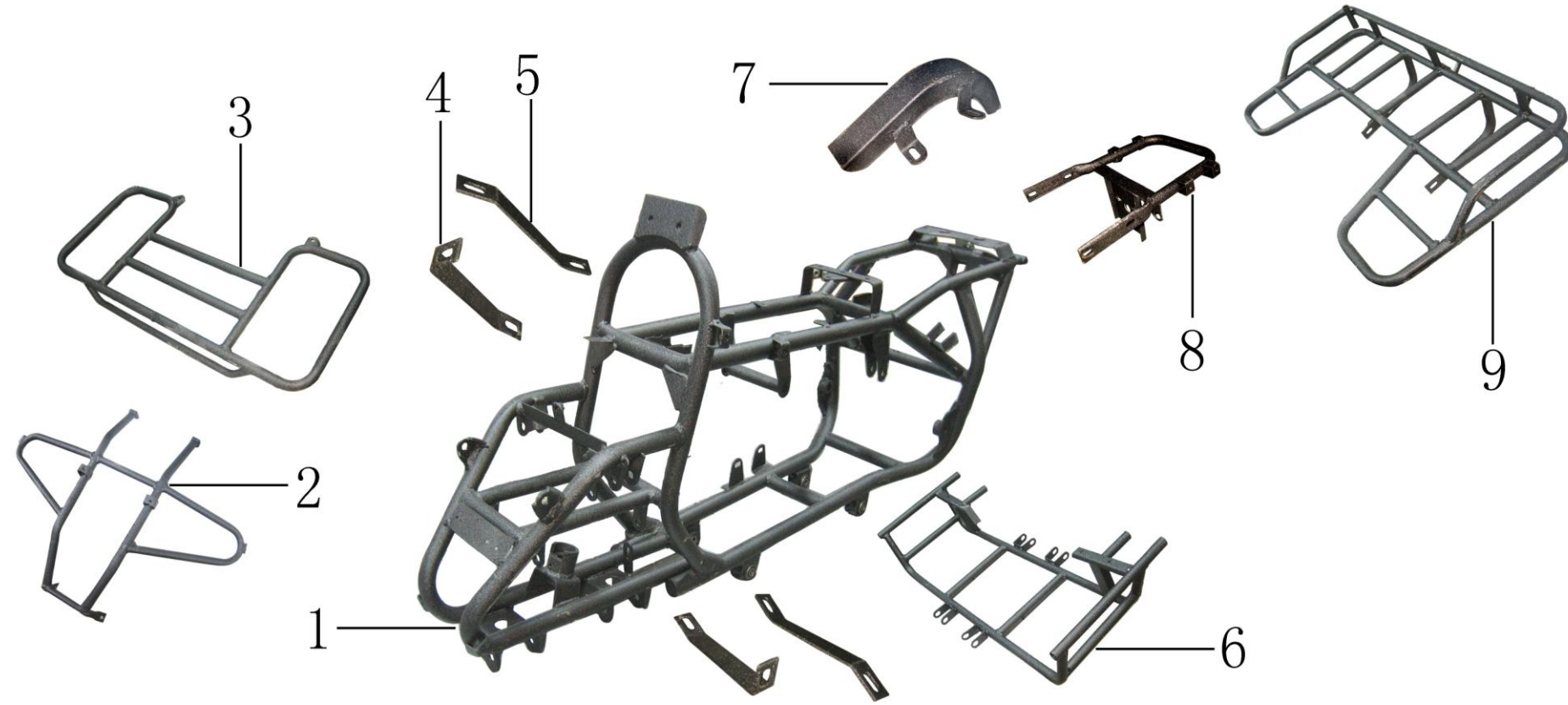

REF NO.	level 1 NO.	PART NO.	DESCRIPTION	REMARK	QTY	level 2 NO.	PART NO.	DESCRIPTION	REMARK	QTY
1	1	GB000B10000001	FRAME	车架	1					
2	2	GB000F310000000	BUMPER	前保险杠	1					
3	3	GB000F310000001	FRONT RACK	前货架	1					
4	6	GB000F130000000	FOOTREST BRACKET	脚踏板支架	1					
5	7	GB000F320000002	CHAIN COVER	挡链罩	1					
6	9	GB000F310000002	REAR RACK	后货架	1					

2. STEERING SYSTEM

LE
VE
L1

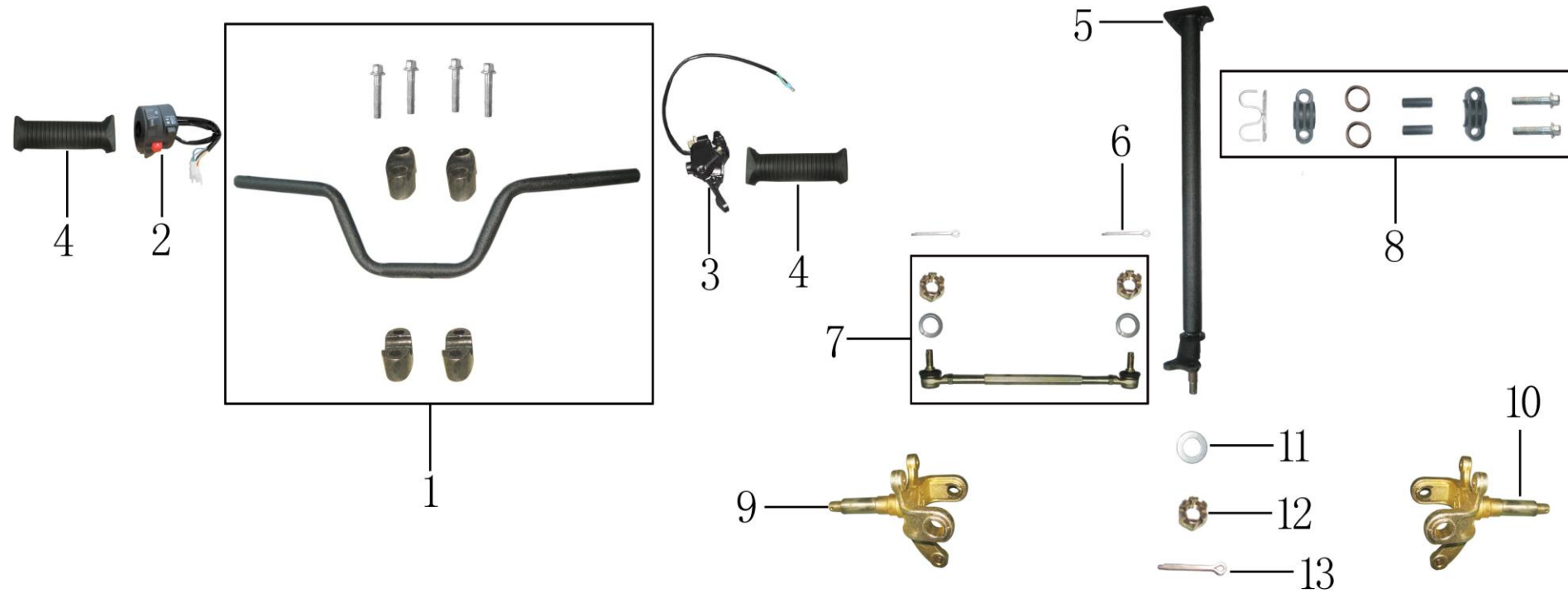

LE
VE
L2

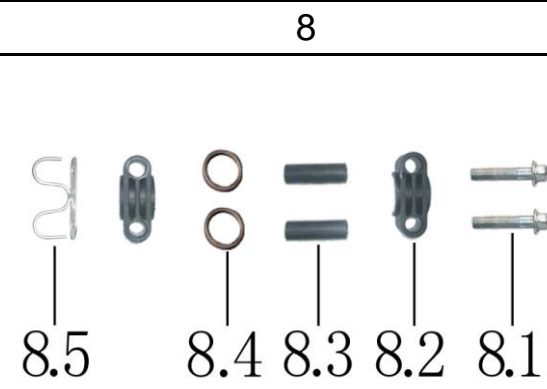
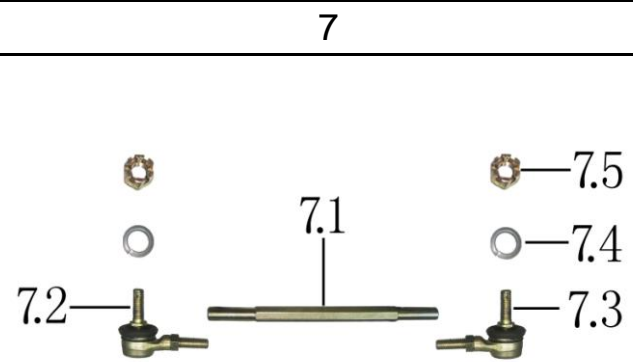
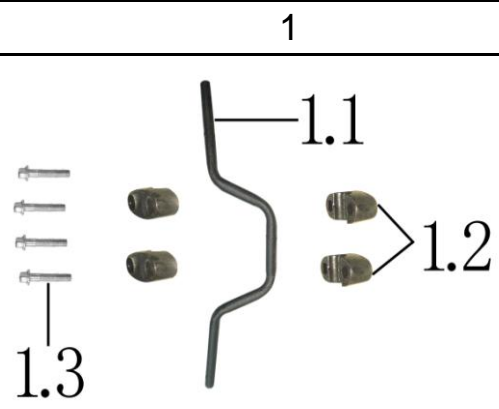

REF NO.	level 1 NO.	PART NO.	DESCRIPTION	REMARK	QTY	level 2 NO.	PART NO.	DESCRIPTION	REMARK	QTY
1	1	GB000C10000000	HANDLE BAR ASSY	把手管组件	1	1.1	GB000C110000000	HANDLE	把手管	1
2						YS000C220000000	HANDLE FIXER	把手管固定块	4	
3						G587M08L60D88ZS0	BOLT M8*60	六角法兰面螺栓B级	4	
4	2	GB000D710000000	STARTING SWITCH	左组合开关	1					
5	3	TE000E810000000	THROTTLE CONTROL	加油器	1					
6	4	SA000C150000000	HAND GRIP	把手套	2					
7	5	GB000C310000000	STEERING POLE	方向柱	1					
8	6	G117D2P5L032ZS0	COTTER PIN d2.5*32	开口销	4					
9	7	GB000C320000001	STEERING LINK L260	转向拉杆组件	1	7.1	GB000C320000002	TIE-ROD	转向拉杆主体	1
10						7.2	GB000C330000000	LINK KNUCKLE I	转向拉杆球头(正丝)	1
11						7.3	GB000C330000001	LINK KNUCKLE II	转向拉杆球头(反丝)	1
12						7.4	G093M10S26B26000	WASHER d10	弹簧垫圈	2
13						7.5	G181M10D08ZG0	NUT M10	六角开槽螺母	2
14	8	GB000C260000000	STEERING CLIP ASSY	方向柱固定件	1	8.1	G587M08L55D88ZS0	BOLT M8*55	六角法兰面螺栓B级	2
15						8.2	SB000C220000000	CLIP	方向柱固定块	2
16						8.3	SG000P110000002	STEERING BUSH d10.3*D14*L42	金属隔套	2
17						8.4	G521D30P0B3P55	WINDTIGHT RING	O形密封圈	2
18						8.5	SB000C330000000	WIRING CLIP	方向柱线卡	1
19										
20	9	GB000C410000000	STEERTING KNUCKLE(LF)	左转向节	1					
21	10	GB000C410000001	STEERING KNUCKLE(RH)	右转向节	1					
22	11	G971M14D28H25ZS0	WASHER d14	平垫圈	1					
23	12	G181M14E08ZG0	BOLT M14	六角开槽螺母	1					
24	13	G117D2P5L032ZS0	COTTER PIN	开口销	1					

3.SUSPENSION SYSTEM

LE
VE
L1

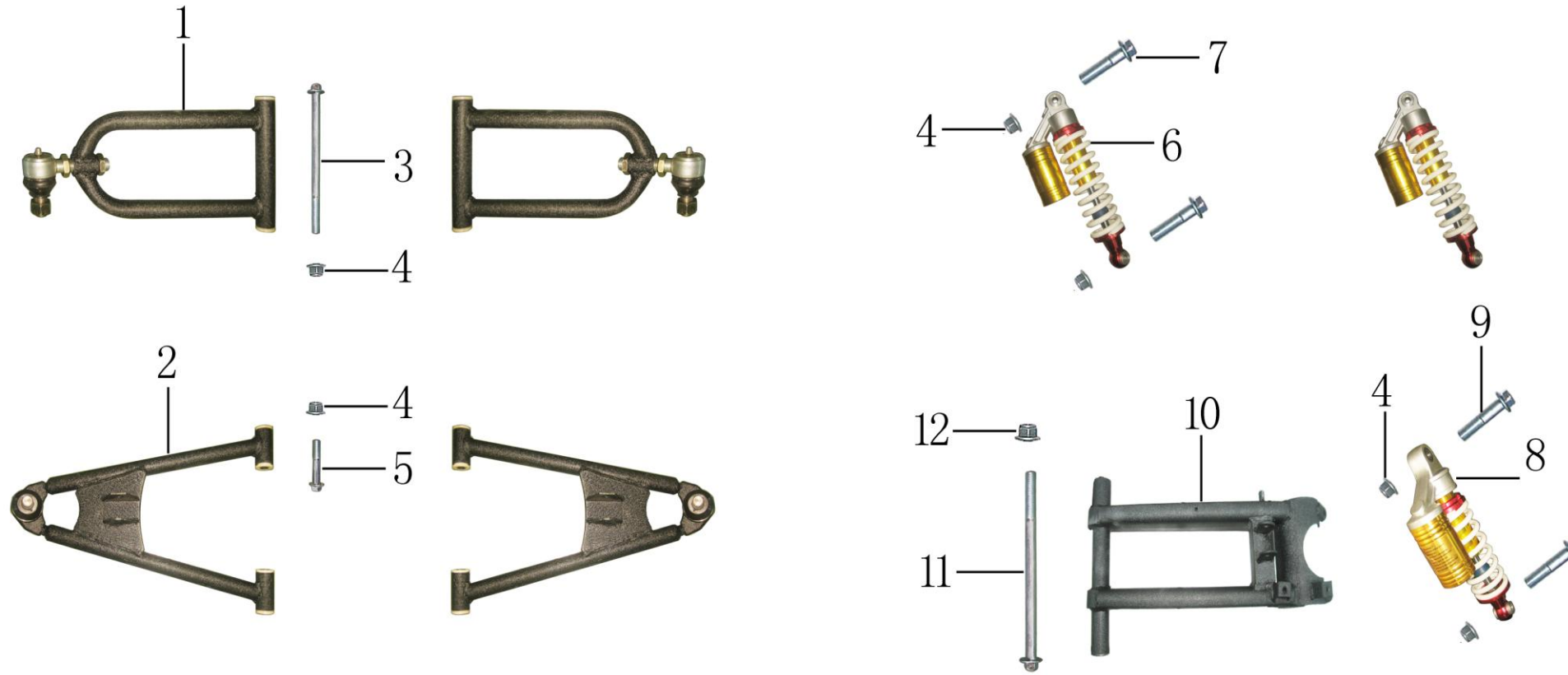

LE
VE
L2

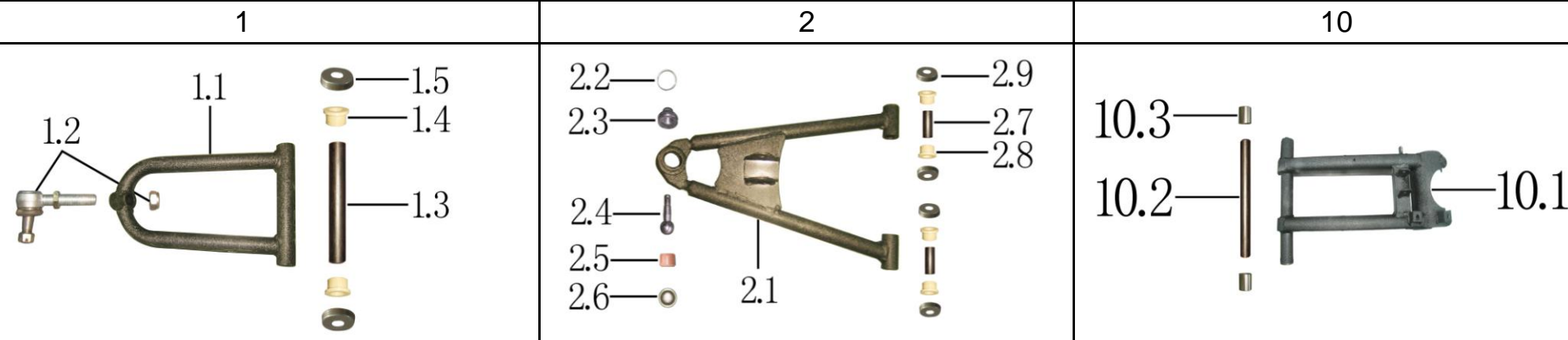

REF NO.	level 1 NO.	PART NO.	DESCRIPTION	REMARK	QTY	level 2 NO.	PART NO.	DESCRIPTION	REMARK	QTY
1	1	GB000N100000003	UPPER A-ARM ASSY	前上摇架组件	2	1.1	GB000N100000000	FRONT UPPER A-ARM	前上摇架	1
2						1.2	GB000N100000001	UPPER A-ARM KNUCKLE	上摇架可调球头	1
3						1.3	GB000P11YB00000	METAL BUSH d10.3*D14*L167	金属隔套	1
4						1.4	GB000P220000000	A-ARM PLUG	非金属台阶隔套	2
5						1.5	GB000N160000000	A-ARM COVER	摇架防尘盖	2
6						2.1	GB000N100000002	LOWER A-ARM(LEFT)	前下摇架	1
7						2.2	GB000N150000002	ARM KNUCKLE RUBBER CLIP	前摇架球头防尘套卡簧	1
8	2	GB000N100000004	LOWER A-ARM ASSY	前下摇架组件	2	2.3	GB000N150000001	ARM KNUCKLE RUBBER	前摇架球头防尘套	1
9						2.4	GB000N150000000	LOWER A-ARM KNUCKLE	下摇架球头	1
10						2.5	GB000N150000003	ARM KNUCKLE BUSH	前球头缓冲套	1
11						2.6	GB000N150000004	ARM KNUCKLE COVER	前摇架球头限位盖	1
12										
13										
14										
15	3	G587M10L80D88ZS0	BOLT M10*80	六角法兰面螺栓B级	2					
16	4	Q141M10D08ZS0	NUT M10	六角法兰面自锁螺母	12					
17	5	G587M10L80D88ZS0	BOLT M10*80	六角法兰面螺栓B级	4					
18	6	GB000N310000000	REAR SHOCK L305	前减震器	2					
19	7	G587M10L45D88ZS0	BOLT M10*45	六角法兰面螺栓B级	4					
20	8	GB000N310000002	REAR SHOCK L270	后减震器	1					
21	9	G587M10L55D88ZS0	BOLT M10*55	六角法兰面螺栓B级	2					
22	10	GB000N200000001	REAR SWING ARM	后平叉	1					
23	11	G587M08L95D88ZS0	BOLT M8*95	六角法兰面螺栓B级	1					
24	12	Q141M08D08ZS0	NUT M8	六角法兰面自锁螺母	1					

4.ELECTRIC SYSTEM

LEVEL 1

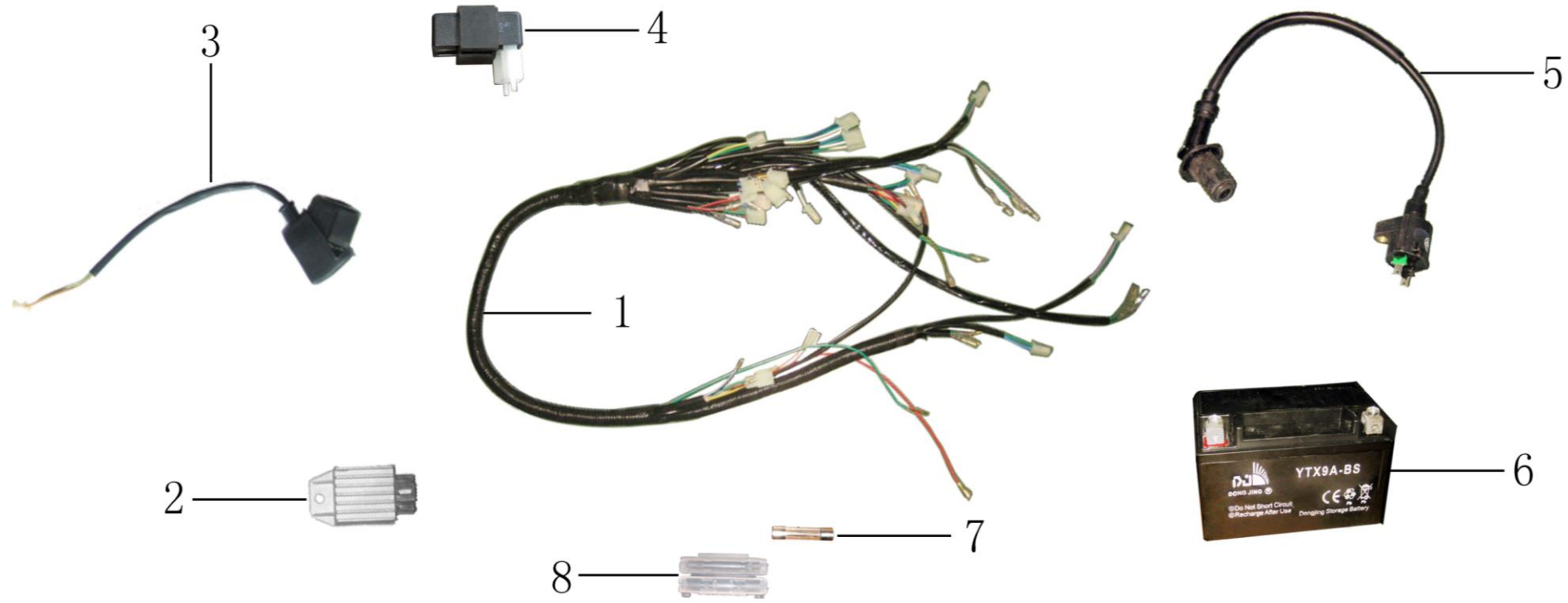

REF NO.	level 1 NO.	PART NO.	DESCRIPTION	REMARK	QTY	level 2 NO.	PART NO.	DESCRIPTION	REMARK	QTY
1	1	GB000D110000000	WIRE HARNESS	主电缆	1					
2	2	SL000D440000000	REGULATOR	整流器	1					
3	3	SB000D430000000	STARTER RELAY	继电器	1					
4	4	SL000D410000000	C.D.I	点火器	1					
5	5	SL000D420000000	IGNITION COIL	高压包	1					
6	6	ZAG00D610000000	BATTERY	蓄电池	1					
7	7	SB000D220000000	FUSE	保险丝	1					
8	8	SB000D220000001	FUSE BOX	保险丝盒	1					

5. TRANSMISSION SYSTEM

LE
VE
L1

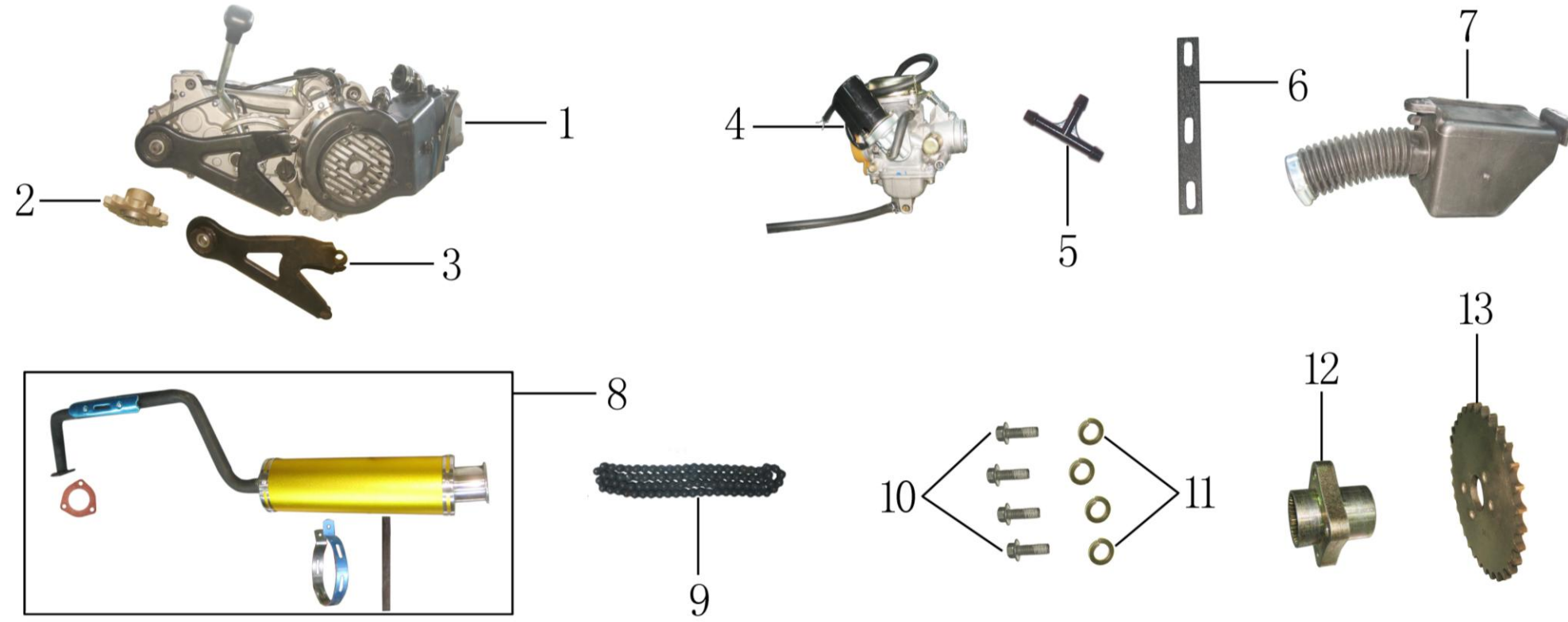

LE
VE
L2

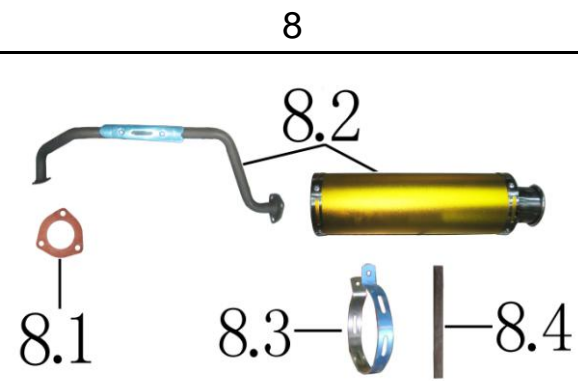
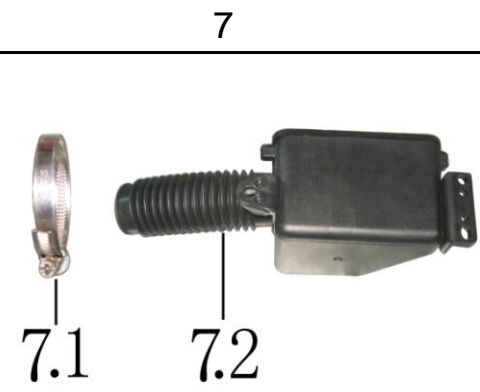

REF NO.	level 1 NO.	PART NO.	DESCRIPTION	REMARK	QTY	level 2 NO.	PART NO.	DESCRIPTION	REMARK	QTY
1	1	SL000J100000000	ENGINE	发动机	1					
2	2	GB000M100000005	FRONT SPROCKET	输出链轮	1					
4	4	SB000E520000000	CARBURETOR PD24J	化油器	1					
7			admission pipe	进气管	1					
8	7	GB000A000000000	AIR FILTER ASSY	空气滤清器组件	1	7.1	Q620AD50000	CIRCLIP	A型蜗杆传动式软管环箍	1
9						7.2	GB000A300000000	AIR FILTER	空气滤清器	1
10	8	GB000A200000001	ALUMINIUM EXHAUST ASSY	排气消声器组件	1	8.1	GB000A250000002	EXHAUST WASHER	排气消声器隔热垫	1
11						8.2	GB000A200000000	MUFFLER	排气消声器	1
12						8.3	GB000A250000000	MUFFLER HOOP	排气消声器抱箍	1
13						8.4	GB000A250000001	WASHER	排气消声器抱箍缓冲带	1
14	9	GB000M100000004	CHAIN 530#94节	链条	1					
15	10	G587M08L25D88ZS0	BOLT M8*25	六角法兰面螺栓B级	4					
16	11	G859M08S16B25000	WASHER d8	弹簧垫圈	4					
17	12	GB000M150000000	SPROCKET FLANGE	链盘法兰	1					
18	13	GB000M100000002	REAR SPROCKET	后链盘	1					

6.FUEL TANK

LE
VE
L1



1

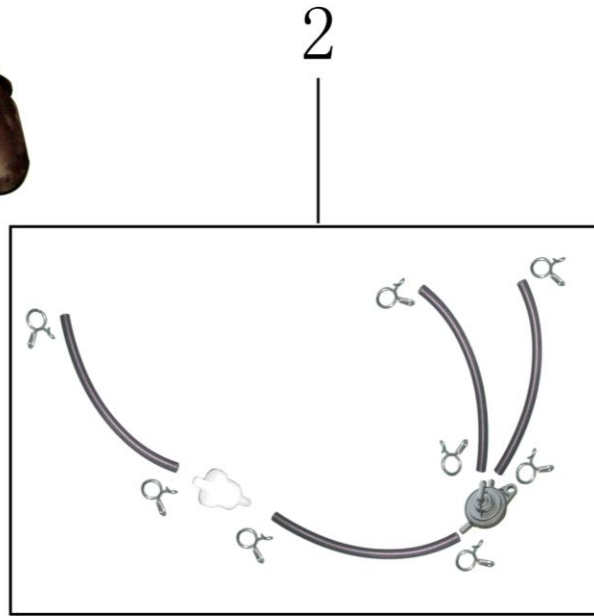

2



3

LE
VE
L2

1



1.1

1.2

2

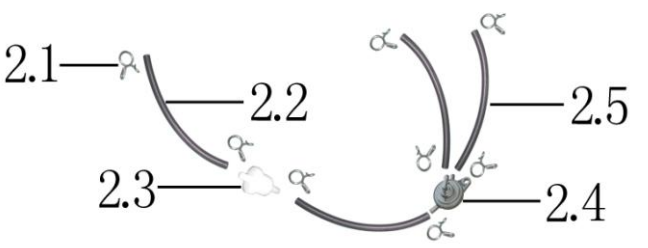

2.1

2.2

2.5

2.3

2.4

REF NO.	level 1 NO.	PART NO.	DESCRIPTION	REMARK	QTY	level 2 NO.	PART NO.	DESCRIPTION	REMARK	QTY
1	1	GB000E100000000	FUEL TANK ASSY	燃油箱组件	1	1.1	GB000E150000000	FUEL TANK CAP	燃油箱盖	1
2						1.2	GB000E110000000	FUEL TANK	燃油箱	1
3	2	GB000E200000000	FUEL FILTER	燃油过滤器组件	1	2.1	Q621AB7000	CIRCLIP B7	钢丝弹性环箍	8
4						2.2	YF000E610000000	FUELTUBE d4.5*D8.5*L100	燃油管	2
5						2.3	SB000E210000000	FUEL FILTER	燃油过滤器	1
6						2.4	GB000E310000000	FUEL SWITCH	负压燃油开关	1
7						2.5	YF000E610000001	FUELTUBE d4.5*D8.5*L150	燃油管	2
8										
9										
10	3	GB000M200000000	THROTTLE CABLE 1000*100	油门拉线	1					

7.REAR AXLE

LE
VE
L1

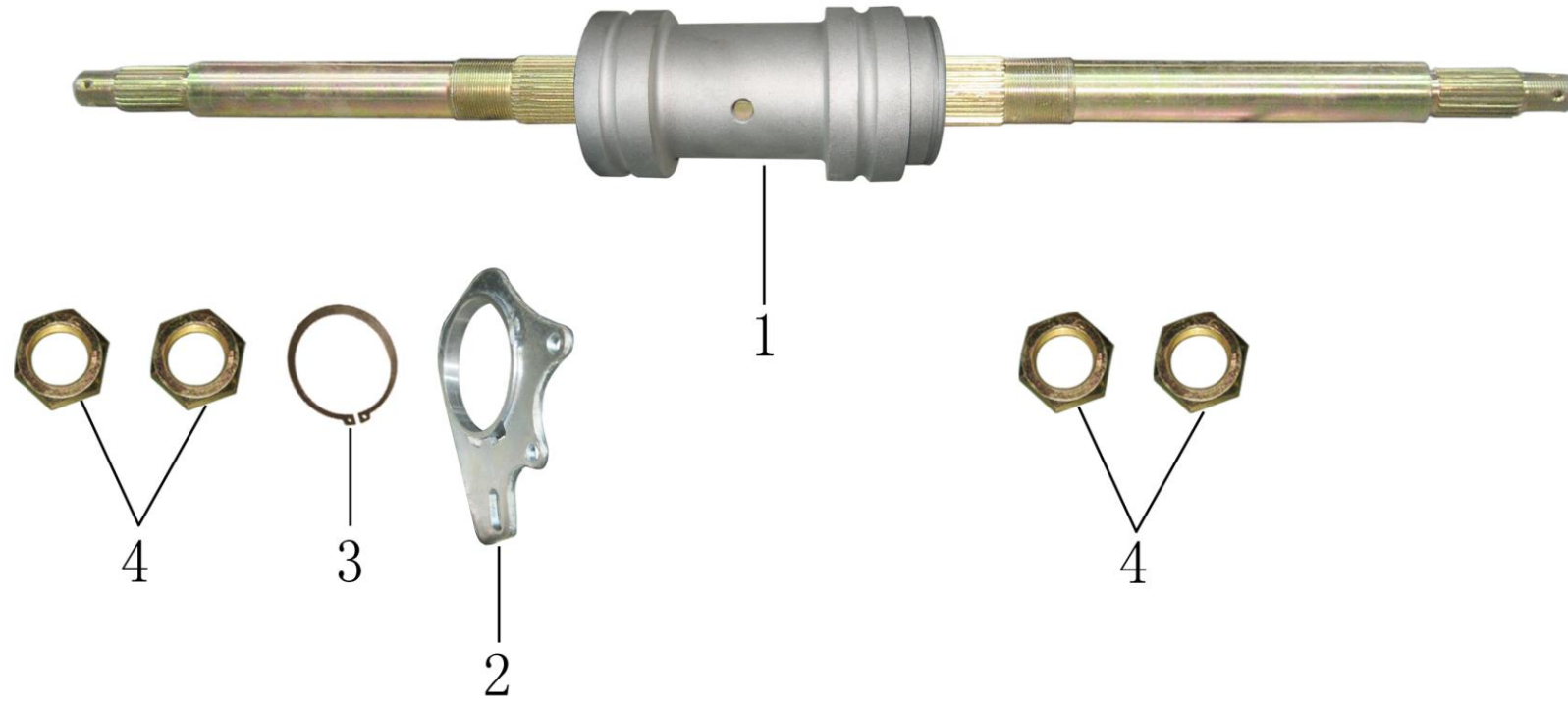

LE
VE
L2

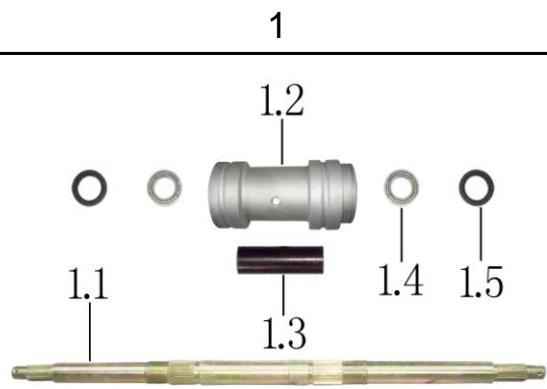

REF NO.	level 1 NO.	PART NO.	DESCRIPTION	REMARK	QTY	level 2 NO.	PART NO.	DESCRIPTION	REMARK	QTY
1	1	GB000M500000002	REAR AXLE ASSY	后桥总成组件	1	1.1	GB000M100000003	REAR AXLE L800	后桥传动轮轴	1
2						1.2	GB000M500000001	REAR AXLE CONNECTION ROD	后桥铸件	1
3						1.3	GB000P11YB00004	METAL BUSH d36*D42*L129	金属隔套	1
4						1.4	G276AS6007	BEARING 6007Z	深沟球轴承	2
5						1.5	G871D040D062B08	OIL SEAL 40*62*8	油封	2
6										
7										
8	2	GB000M850000002	REAR CALIPER BRACKET	后盘式制动器固定支架	1					
9	3	GB000M850000003	REAR CALIPER BRACKET CLIP	后盘式制动器固定支架卡簧	1					
10										
11	4	GB000P41ZG00000	NUT	六角螺母	4					

8.BODY KITS

LE
VE
L1



LE
VE
L2

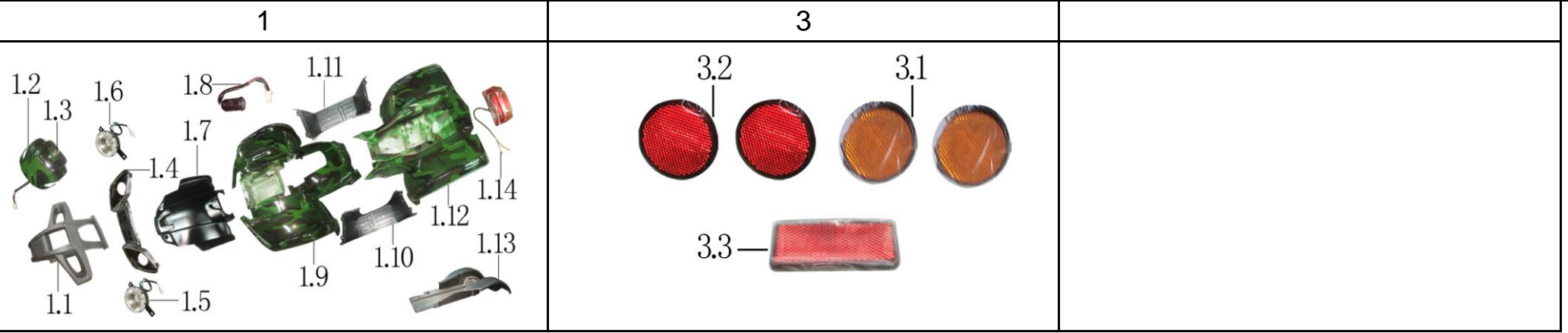





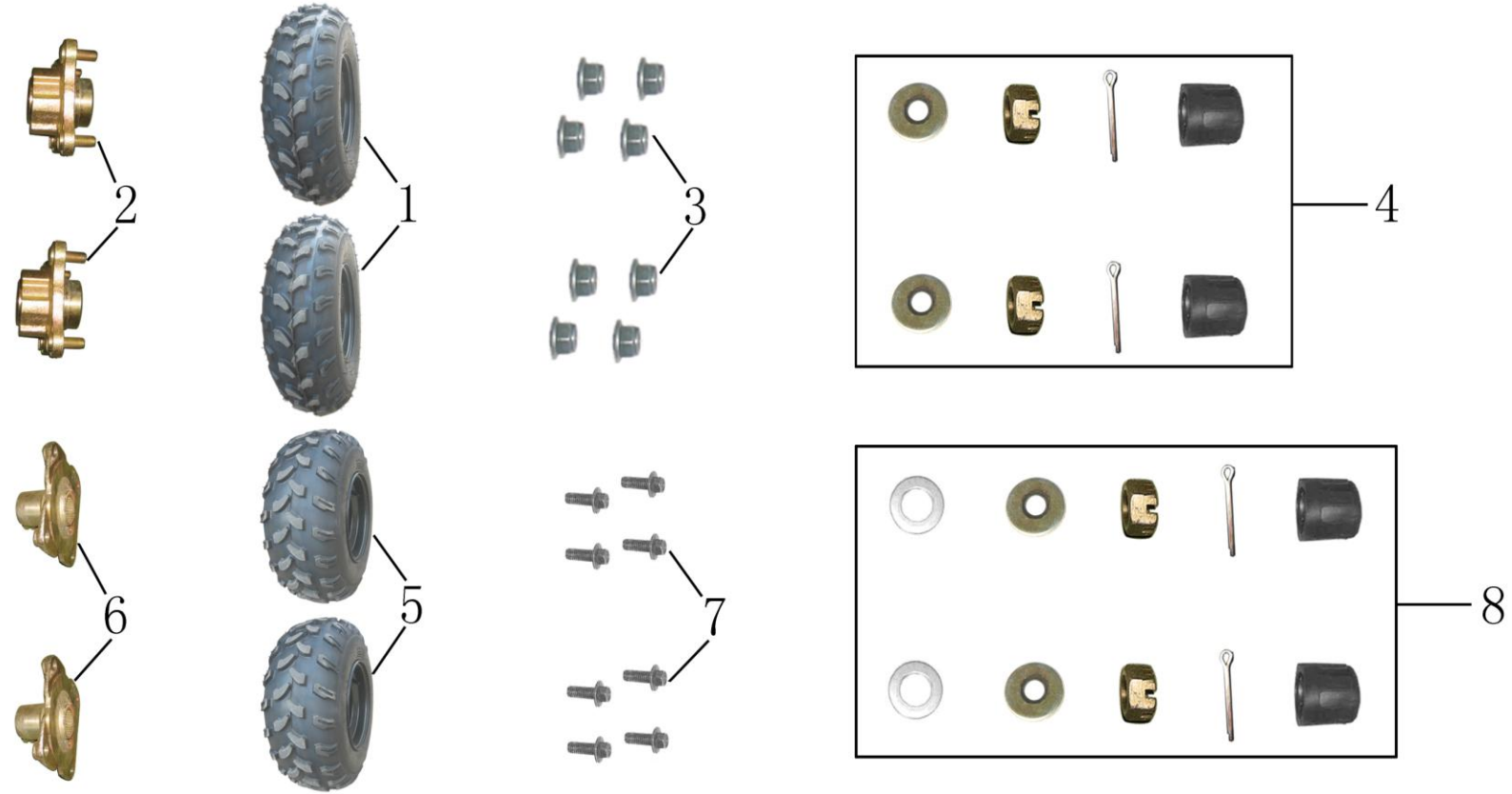











9.WHEEL COMPLETE

LEVEL 1



LEVEL 2

	1	4	5	
	 1.1  1.2  1.3  1.4	 4.1  4.2  4.3  4.4	 5.1  5.2  5.3  5.4	
	8			
	 8.1  8.2  8.3  8.4  8.5			

10.HYDRAULIC BRAKE

LEVEL 1

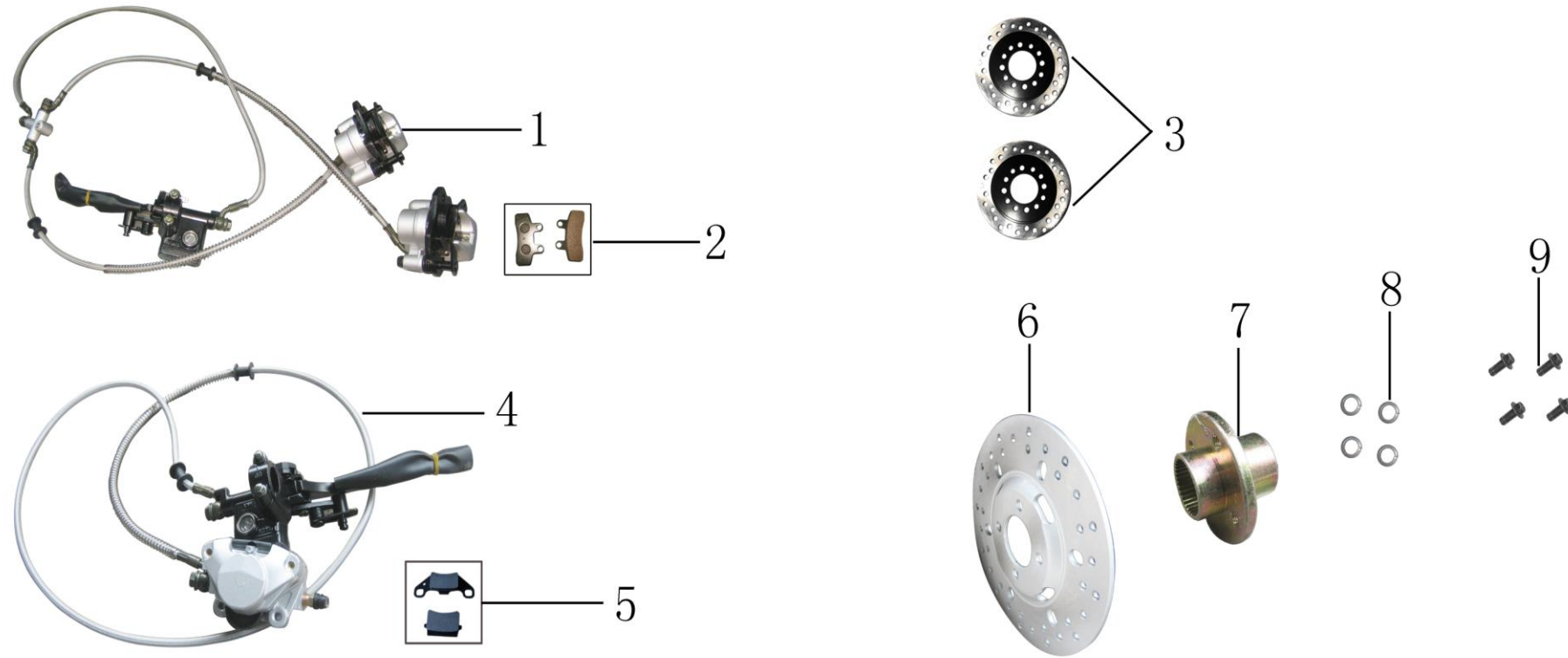

REF NO.	level 1 NO.	PART NO.	DESCRIPTION	REMARK	QTY	level 2 NO.	PART NO.	DESCRIPTION	REMARK	QTY
1	1	GB000M800000001	FRONT CALIPER	前盘式制动器	2					
2	2	TE000M810000000	FRONT BREAK PADS	前制动器蹄块	1					
3	3	SL000M800000001	FRONT ROTOR	前制动盘	2					
4	4	GB000M800000002	REAR CALIPER	后盘式制动器	1					
5	5	YF000M810000000	REAR BRAKE PADS	后制动蹄块	1					
6	6	GB000M800000000	REAR ROTOR	后制动盘	1					
7	7	GB000M850000000	ROTOR FLANGE	后制动盘法兰	1					
10	8	G587M08L16D88ZS0	WASHER d8	弹簧垫圈	4					
11	9	G859M08S16B25000	BOLT M8*16	六角法兰面螺栓B级	4					